

## *Kakovostna, zanesljiva, modna*



### Sladoledna vitrina

- ventilacijsko hlajenje s pol-hermetičnim kompresorjem
- dva zaščiteni evaporatorja
- avtomatsko odtaljevanje z inverzijo cikla
- ogrevano prednje steklo z dvižnim odpiranjem
- ogrevana termopan stranska stekla
- zapiranje z zaveso na delovni strani

Možno je sestavljanje več vitrin skupaj.

### Vitrina za sladice

- ventilacijsko hlajenje
- močan evaporator zagotavlja visoko vlago
- avtomatsko odtaljevanje s toplim plinom
- ogrevano prednje steklo z dvižnim odpiranjem
- ogrevana termopan stranska stekla
- ena steklena polica
- zapiranje z zaveso na delovni strani

## Izvedbe

### Standardna prednja plošča



Daniel's with magenta



Daniel's with blue



White with red



Daniel's with orange



Daniel's with green

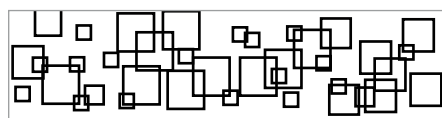

Karo



White with neon



Black with neon

### Enobarvna prednja plošča



Rdeča



Modra



Rumena

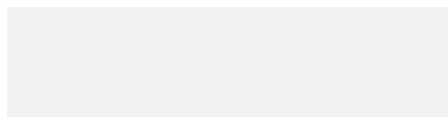

Bela



Siva



Oranžna

### Na zahtevo

Izbira prednje plošče v drugi barvi po lestvici RAL ali NCS; prednja plošča iz akrilnega stekla z LED osvetlitvijo

## Tehnični podatki

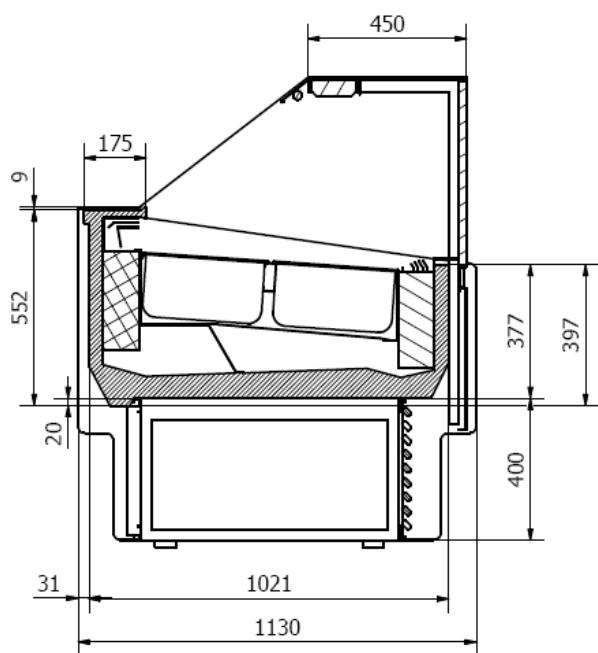

Sladoledna vitrina

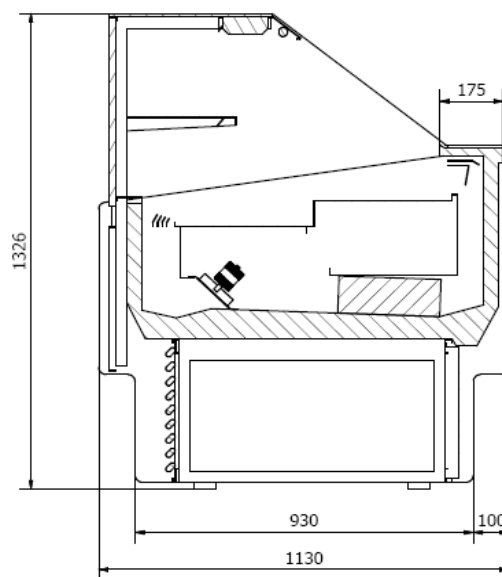

Vitrina za sladice

## Modeli

### 12 G

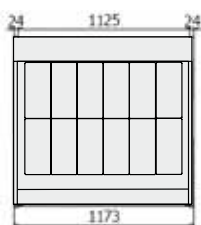

### 16 G

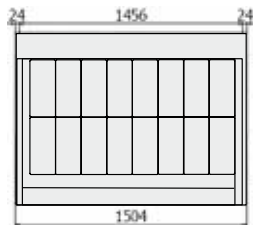

### 18/20 G

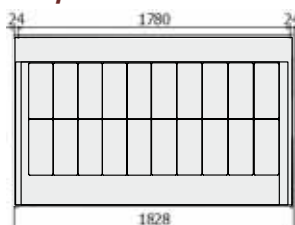

### 24 G

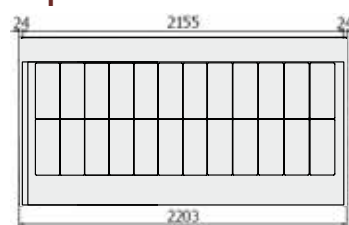

Vitrine za sladice na razpolago v istih dimenzijah, označene z modeli 12P, 16P, 18/20P in 24P

## Dodatki

- kolesa z zavoro ali brez zavor
- banjica za pranje žlic s cirkulacijo vode ali brez cirkulacije vode
- magnetni napisi za sladoled
- banjice za sladoled:
  - 5-litrške 360x250x80 mm
  - 5-litrške 360x165x120 mm
  - 6,5-litrške 360x165x15 mm

## Tehnični podatki

Modul	Delovna temperatura	Električni priključek	Skupna moč	Moč pri odtaljevanju	Neto teža	Dolžina
	°C	V/Ph/Hz	W	W	kg	mm
12 G	-15 / -22	400/3/50	1660	1790	218	1173
16 G	-15 / -22	400/3/50	2340	2640	280	1504
20 G	-15 / -22	400/3/50	2630	3030	308	1828
24 G	-15 / -22	400/3/50	3020	3680	355	1770

Velja za vse modele : hladilni plin R404a, testna temperatura 35°C / 70% RH (razred 4/4+)

Distributer :



Valmar d.o.o.  
Vinka Vodopivca 14, 5000 Nova Gorica, Slovenija  
T+386 5 335 24 00 | F +386 5 335 24 20  
info@valmar.si | www.valmar.si